

ROHDE & SCHWARZ

Make ideas real



R & S[®] ESSENTIALS

FUNDAMENTALS OF DC POWER SUPPLIES

Output characteristics

Flyer | Version 02.00



DESIGN AND OPERATION



POWER SUPPLY DESIGNS

There are three basic types of power supplies based on different design principles:

- ▶ Linear power supplies
- ▶ Switched-mode power supplies (SMPS)
- ▶ Mixed architecture power supplies

Linear power supplies

Linear regulated power supplies provide highly constant output voltage, low ripple and noise and fast regulation, even with high line and load transients. They produce significantly less electromagnetic interference than switched-mode power supplies.

A conventional mains transformer isolates the power-line from the secondary circuits (output stages). It is followed by a rectifier that supplies the unregulated voltage to a series actuator. Capacitors at the input and output of the regulator circuit serve as buffers and decrease the ripple. A high precision reference voltage controls the analog output amplifier. This amplifier is generally fast and allows very short recovery times for load changes.

Linear power supply

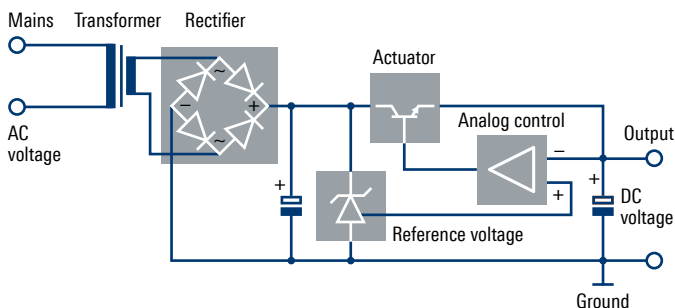

Switched-mode power supplies (SMPS)

SMPS have much higher efficiency than linear regulated power supplies. In a first step, the line voltage is rectified. Due to the high input voltage, buffer capacitors with a small capacitance can be used. In a second step, the DC voltage to be converted is chopped at a high frequency. This takes place in the switching transistor and requires only comparatively tiny and light ferrite chokes or transformers with low losses. The switching transistor is switched fully on and off, hence switching losses are low. The output voltage is usually regulated by changing the duty cycle of the switching transistor. A rectifier and low-pass filter improve the output quality.

Switched-mode power supply

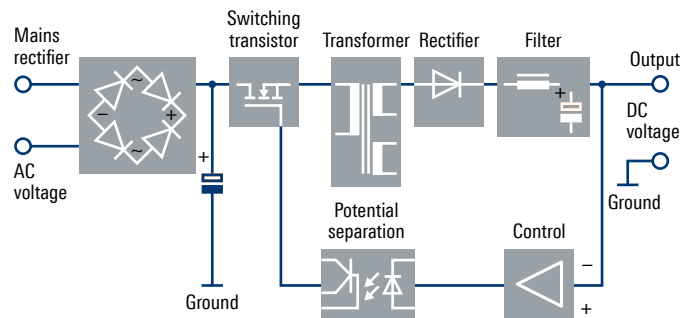

Compared to linear power supplies, SMPS achieve considerably higher efficiency of approx. 70% to over 95%. They are lighter and smaller. The capacitor(s) on the output(s) of an SMPS may be quite small due to the high switching frequency, but the choice of the right capacitor(s) also depends on other factors such as the required energy storage capacity and the AC ripple induced by the load (e.g. motors). The size of the major components generally

decreases with increasing operating frequency. However, efficiency drops appreciably above approx. 250 kHz as the losses in all components rise sharply.

Mixed architectures

Different combinations of the above basic designs are in use. For example, the R&S®NGE100B power supplies use a mains transformer at the input, followed by a rectifier and switched-mode circuitry to regulate the output voltage, providing high efficiency. A linear stage reduces unwanted signal components at the output.

Basic types of power supplies			
Power supply	Linear	Mixed	Switched mode
R&S®HMC804x			•
R&S®NGE100B		•	
R&S®NGA100	•		
R&S®HMP2000/4000		•	
R&S®NGP800			•
R&S®NGL200	•		
R&S®NGM200	•		
R&S®NGU201/401	•		

ONE, TWO OR FOUR QUADRANTS – SOURCE AND SINK OPERATION

A standard power supply typically acts as a source of power, meaning that current flows out of the positive voltage terminal. This type of power supply is also called unipolar as it delivers voltage with a single polarity (see first quadrant in the figure below).

Quadrants of DC power supplies

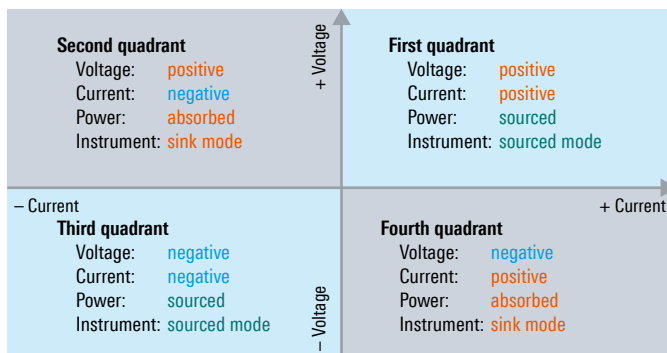

If current flows into the positive voltage terminal, the power supply acts as an electronic load. It is sinking power instead of sourcing power. Instruments that function both as a source and sink can simulate batteries or loads; they are called two-quadrant (or four-quadrant) power supplies.

Rohde&Schwarz specialty power supplies offer two- and four-quadrant architecture. The instruments automatically switch from source to sink mode. When the externally applied voltage exceeds the set nominal voltage, current flows into the power supply, which is indicated by a negative current reading.

The architecture of power supplies can be fully defined using a Cartesian coordinate system. The four quadrants show all combinations of positive and negative voltage and current. The figure below illustrates a coordinate system with voltage on the vertical and current on the horizontal axis.

As mentioned above, standard power supplies typically generate voltage of positive polarity only (i.e. they work in the first quadrant), for example from 0 V to 20 V. If a power supply can provide either positive or negative voltage at its output terminals without having to switch the external wiring, it is referred to as a bipolar power supply and will work in quadrants 1 and 3, providing voltages from -20 V to +20 V, for example. Such instruments can be used, among other things, to test the characteristic behavior of semiconductors for bipolar voltages across the 0 V point.

Power supplies that can operate in quadrants 1 and 3 typically also offer sink functionality for positive and negative voltages and currents. They can operate in all four quadrants and are referred to as source measure units (SMUs). In the first and third quadrant, current flows out of the voltage terminal; the instrument is sourcing power. In the second and fourth quadrant, current flows into the voltage terminal; the instrument is sinking power.

One, two or four quadrants			
Power supply	One quadrant	Two quadrants	Four quadrants
R&S®HMC804x	•		
R&S®NGE100B	•		
R&S®NGA100	•		
R&S®HMP2000/4000	•		
R&S®NGP800	•		
R&S®NGL200		•	
R&S®NGM200		•	
R&S®NGU201		•	
R&S®NGU401			•

CHANNELS WITH IDENTICAL VOLTAGE RANGES

Most of the Rohde&Schwarz power supplies offer the same voltage range on all channels. This means it does not matter which channel you choose for a specific application. Each channel can be regarded as a separate power supply.

RIPPLE AND NOISE

Advanced, complex electronic circuitry is very sensitive to voltage variations on the supply lines. To minimize interference when powering devices under test (DUTs), power supplies must provide extremely stable output voltages and currents. Ideally, an output is free from voltage variations. In practice, there are two types of variation that can possibly affect the circuit or device: periodic variations (ripple) and random variations (noise), also referred to as periodic and random deviations (PaRD). Linear power supplies exhibit significantly lower high-frequency ripple compared to switched-mode power supplies.

Specialty power supplies as well as some basic power supplies such as the R&S®NGA100 employ linear voltage regulation for minimal residual ripple and noise.

Ripple and noise

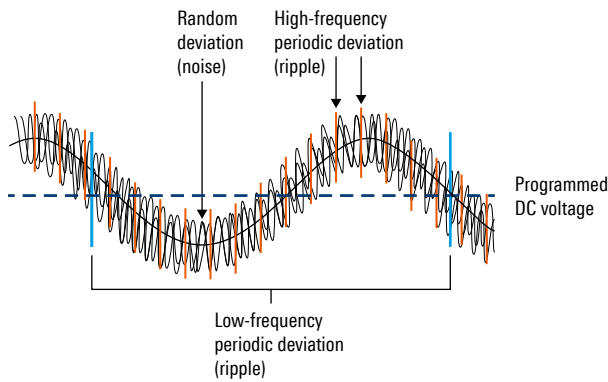

The linear design of the output stages makes it possible to supply low-interference voltage to sensitive designs such as complex semiconductors. Low ripple and noise values are also perfect for developing power amplifiers and MMICs.

Ripple and noise (20 Hz to 20 MHz)		
Power supply	Voltage (RMS)	Current (RMS)
R&S®HMC8041	< 1 mV	< 1.5 mA
R&S®HMC8042/43	< 450 µV	< 1 mA
R&S®NGE100B	< 1.5 mV	< 2 mA
R&S®NGA101/102	< 0.5 mV	< 500 µA
R&S®NGA141/142	< 1.5 mV	< 500 µA
R&S®HMP2000/4000	< 1.5 mV	< 1 mA
R&S®NGP800	< 3 mV	< 3.5 mA
R&S®NGL200	< 500 µV	< 1 mA
R&S®NGM200	< 500 µV	< 1 mA
R&S®NGU201/401	< 500 µV	< 1 mA

VARIABLE OUTPUT IMPEDANCE

The outputs of specialty power supplies can be configured in various ways. For example, parameters such as the output impedance, a switch-on delay and different trigger modes can be set. Power supplies should have an output impedance as low as possible to avoid loading effects on the DUT. However, there are applications that require simulating batteries in a controlled manner, or simulating the increase in internal impedance as the battery discharges. The R&S®NGL200, R&S®NGM200 and R&S®NGU201 power supplies support these applications with adjustable output impedance.



Output menu of the R&S®NGM200 power supply.

OUTPUT RESPONSE



It is important to choose a power supply that can follow quickly changing load conditions. If, for example, a device switches from very low to high current consumption, the power supply will take some time before its output reaches its final setting. On the other hand, power supplies can react with overshoots that endanger sensitive DUTs.

Depending on the type of power supply, it will respond to abrupt load changes with slower or faster recovery times.

LOAD RECOVERY TIME

Load recovery time, also referred to as transient response, describes the time required by a DC power supply to reach a set voltage level after a load change. The power supply's output voltage drops when the current suddenly rises. Likewise, a decrease in current causes a momentary increase in the power supply's voltage. Load recovery time is the duration after which a power supply has recovered from such transient caused by a significant load change.

Consumer electronics such as mobile phones and IoT devices require very little power in sleep mode. However, the current increases abruptly when the device switches to transmit mode. A power supply used to power such DUTs must be capable of handling load changes from a few nA to the ampere range with minimum voltage drops and overshoots.

Optimized load recovery time

Voltage regulation of DC power supplies under load transients.

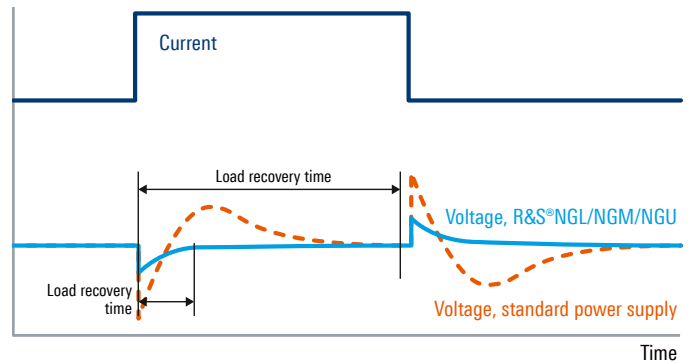

Specialty power supplies have optimized control circuits that react very fast to load changes and minimize overshoots.

The R&S®NGL/NGM series power supplies and the R&S®NGU source measure units allow users to choose how the instrument should respond to load changes.

The “Fast” default setting is optimized for speed, achieving recovery times of $< 30 \mu\text{s}$. Deactivating “Fast” will slightly increase recovery time, focusing on preventing overshoots under special load conditions.

Load recovery time (10 % to 90 % load change)	
R&S®HMC804x	< 1 ms
R&S®NGE100B	< 200 μ s
R&S®NGA101/102	< 100 μ s
R&S®NGA141/142	< 50 μ s
R&S®HMP2000/4000	< 1 ms
R&S®NGP800	< 400 μ s
R&S®NGL200	< 30 μ s
R&S®NGM200	< 30 μ s
R&S®NGU201/401	< 30 μ s

VOLTAGE PRIORITY AND CURRENT PRIORITY MODE

Setting and regulating the output voltage (constant voltage mode) is the standard mode for power supplies.

Most power supplies can also be used in constant current mode, where current limiting ensures that only the configured current can flow. However, these devices are not optimized for fast current limiting. There is a risk of damage to sensitive DUTs due to excessive currents from overshoots in current regulation. To avoid this risk, the R&S®NGU source measure units have separate operating modes for voltage and current regulation.

Voltage priority mode

The standard mode of power supplies provides fast voltage regulation with the risk of overshoots in current.

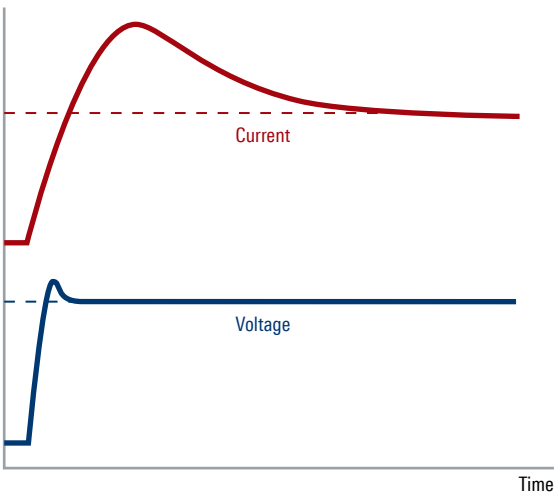

Current priority mode

A special mode for current sensitive DUTs provides fast current regulation. It is the right choice when you have to avoid excessively high currents to protect your DUT.

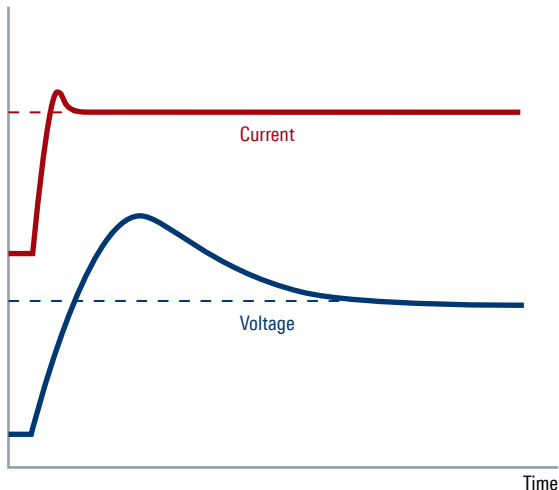

In voltage priority mode, fast voltage regulation provides short recovery times of < 30 μ s. Current regulation is designed to be somewhat slower to avoid the tendency to oscillate.

When precise and quick current regulation is desired, the R&S®NGU source measure units can be operated in current priority mode with a load recovery time of < 50 μ s. Optimized for fast current regulation, this mode allows testing DUTs such as LEDs, which are sensitive to even short current spikes.

CONSTANT VOLTAGE, CONSTANT CURRENT, CONSTANT RESISTANCE

Depending on the application, it is important to keep either the voltage, current or resistance fixed. This is achieved in the CV, CC and CR modes.

In constant voltage (CV) mode, the output voltage is kept constant at the set level, e.g. 5 V, while the current varies as a function of the DUT's behavior and within the set current limits. All Rohde&Schwarz power supplies can also be operated in constant current mode (CC), where each channel can be separately configured. In this mode, a constant preset current flows to the DUT, and the voltage varies, i.e. the output voltage is reduced or increased to keep the current at the set value. When the power supply operates as an electronic load, constant resistance mode (CR) is also available. In this mode, the power supply behaves like a constant, user-settable resistance over the entire load range. This makes it possible to simulate battery discharge behavior with a constant load resistance.

If the DUT load current is low and the current drawn is lower than the set current limit, the power supply will by default operate in CV mode. The voltage is regulated to a constant value, and the current varies as a function of the load. If the load current is high and the load attempts to draw current above the set current limit, the power supply will by default limit the current to the set value and operate in CC mode. The current is regulated and the voltage is determined by the load.

Constant voltage, constant current, constant resistance

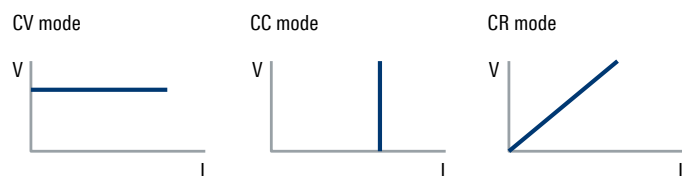

OUTPUT POWER



AUTORANGING: FlexPower

Elementary power supplies often operate in a single range only. Single-range power supplies deliver maximum power P_{max} only at the maximum rated voltage V_{max} and current I_{max} . The left chart in the figure below shows the output characteristics of a single-range power supply.

Multi-range power supplies have wider output voltage and current ranges. The middle chart shows a dual-range power supply.

These power supplies generate a much higher V_{max} or I_{max} within the same maximum power limit as a single-range power supply. Both voltage and current outputs have two operating ranges within the same P_{max} power envelope.

Autorange power supplies have an infinite number of ranges. Rohde & Schwarz autorange power supplies use the FlexPower technology (see right chart).

The Rohde & Schwarz FlexPower feature makes it possible to test a wide range of product families with a single power supply. This substantially extends flexibility, saves space and simplifies the test setup.

FlexPower power supplies are also great when you need high voltage and current, but not a high output power. Using a single-range power supply to meet this need is much more expensive than using a FlexPower power supply.

Maximum power of a DC power supply in a voltage versus current representation

Single-range

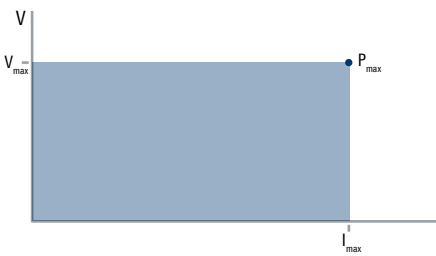

Dual-range

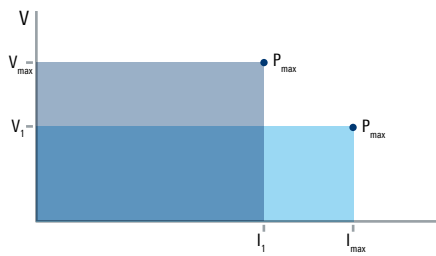

FlexPower

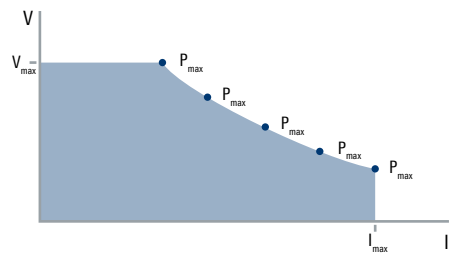

FlexPower		
	Maximum output power	FlexPower
R&S®HMC804x	100 W	•
R&S®NGE100B	100 W	•
R&S®NGA100	80 W	•
R&S®HMP2000/4000	384 W	•
R&S®NGP800	800 W	•
R&S®NGL200	120 W	
R&S®NGM200	120 W	
R&S®NGU201/401	60 W	

PARALLEL AND SERIAL OPERATION

If your application requires more voltage or current than your power supply can provide, simply connect the outputs in series or parallel.

In serial mode, channels can be combined for higher output voltages. Each output needs to be set to the maximum current limit the load can safely handle. Then equally distribute the total desired voltage to each power supply output.

Serial and parallel connection of DC power supply outputs

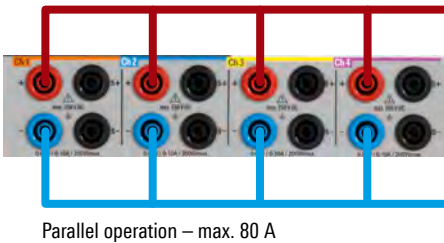
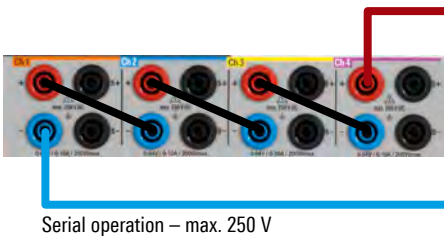

For higher currents, channels can be wired in parallel. Current limiting needs to be equally distributed among the power supply outputs to reach the required total limit.

Using the tracking function, voltage and current are adjusted simultaneously on all selected channels.

For parallel operation in constant voltage mode and serial operation in constant current mode, certain rules have to be observed when configuring the channels in order to reasonably distribute power, voltage and current among the channels.

The R&S®NGA102 and R&S®NGA142 power supplies support channel fusion. With serial or parallel channel fusion, the device acts like a single-channel power supply offering double the voltage or current range. In serial mode, the outputs are connected internally, while parallel mode requires external wiring.

Serial and parallel operation

	Maximum voltage in serial operation	Maximum current in parallel operation
R&S®HMC804x	96 V	10 A
R&S®NGE100B	96 V	9 A
R&S®NGA100	200 V	12 A
R&S®HMP2000/4000	128 V	40 A
R&S®NGP800	250 V	80 A
R&S®NGL200	40 V	12 A
R&S®NGM200	40 V	12 A

PRECISION MADE EASY



R&S® ESSENTIALS

Developers and engineers worldwide have been relying on the T&M expertise of Rohde & Schwarz for more than 80 years. The company is known for providing innovative performance testing solutions and applies its expertise and high quality standards to its portfolio of essential bench instruments – the R&S® Essentials. Rohde & Schwarz is building this industry-defining portfolio, ranging from oscilloscopes, DC power supplies and signal generators to spectrum analyzers, vector network analyzers, meters and counters with the strategic goal of becoming a full portfolio supplier in the T&M market. For R&S® Essentials, Rohde & Schwarz is extending its reach through a distribution network with channel partners worldwide, offering a one-stop shop experience for any type of T&M task, application and budget. Whether in the lab or field, on campus or in a production facility, R&S® Essentials demonstrate that high-quality hardware and software solutions do not have to come with a high price tag.

FROM PRESALES TO SERVICE. AT YOUR DOORSTEP.

The Rohde & Schwarz network in over 70 countries ensures optimum on-site support by highly qualified experts.

User risks are reduced to a minimum at all project stages:

- ▶ Solution finding/purchase
- ▶ Technical startup/application development/integration
- ▶ Training
- ▶ Operation/calibration/repair

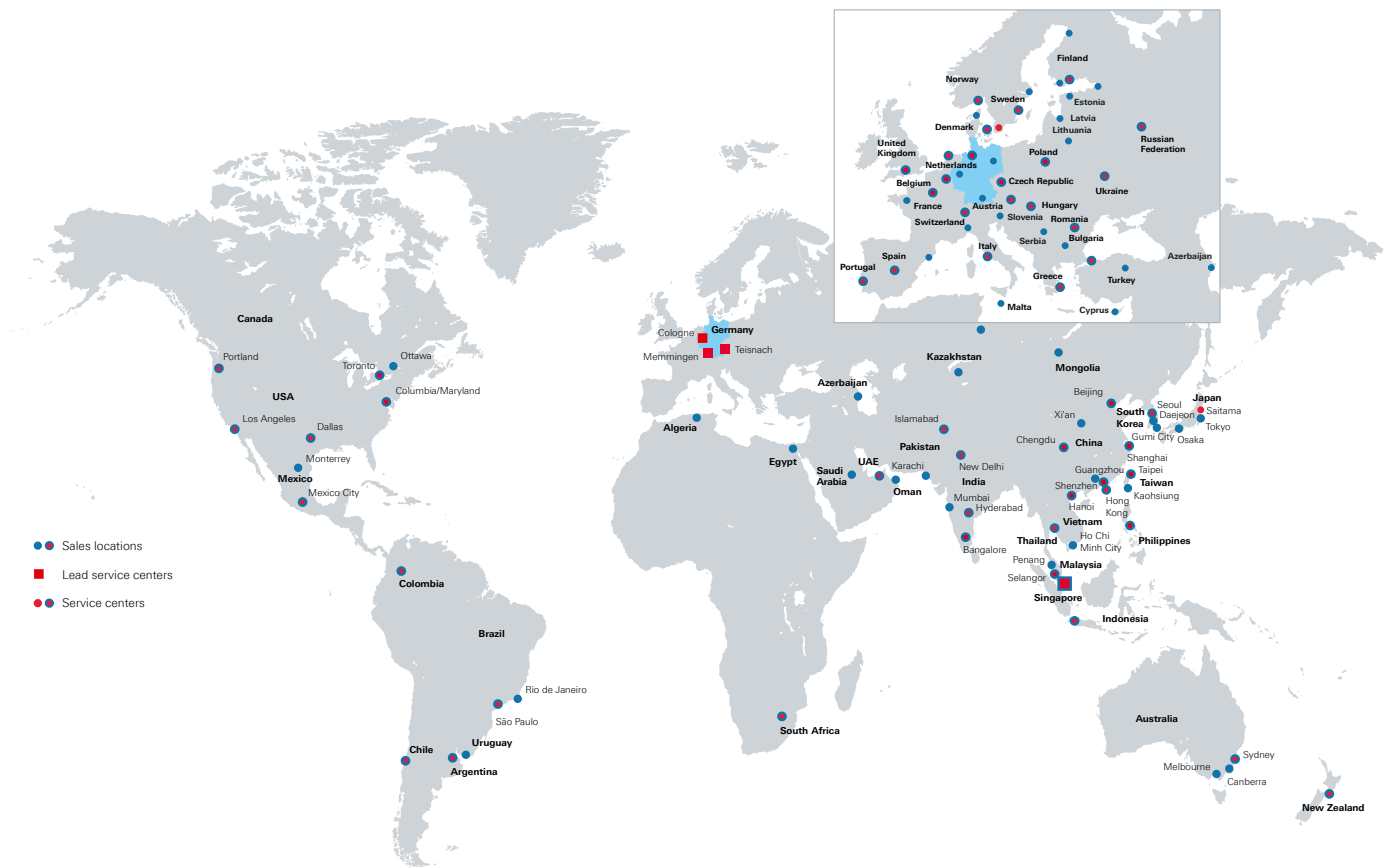

Service that adds value

- ▶ Worldwide
- ▶ Local and personalized
- ▶ Customized and flexible
- ▶ Uncompromising quality
- ▶ Long-term dependability

Rohde & Schwarz

The Rohde & Schwarz technology group is among the trailblazers when it comes to paving the way for a safer and connected world with its leading solutions in test and measurement, technology systems, and networks and cybersecurity. Founded more than 85 years ago, the group is a reliable partner for industry and government customers around the globe. The independent company is headquartered in Munich, Germany and has an extensive sales and service network with locations in more than 70 countries.

www.rohde-schwarz.com

Sustainable product design

- ▶ Environmental compatibility and eco-footprint
- ▶ Energy efficiency and low emissions
- ▶ Longevity and optimized total cost of ownership

Certified Quality Management

ISO 9001

Certified Environmental Management

ISO 14001

Rohde & Schwarz training

www.training.rohde-schwarz.com

Rohde & Schwarz customer support

www.rohde-schwarz.com/support

